

ø8 mm

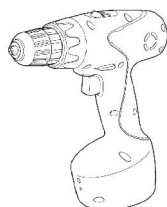

ø3 mm

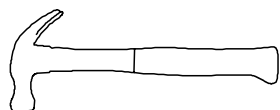

ø12 mm  
ø8 mm

**ATTENTION!!!.**  
pour éviter d'abimer vos  
pièces de bois, il faut les  
pré-percer avant de visser

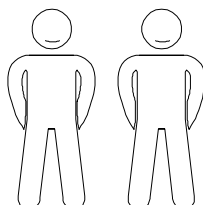
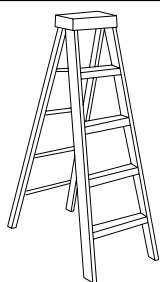



Les dimensions données sur le plan de soubassement sont les dimensions de la dalle béton à réaliser sur un sol parfaitement plat sans aucun autre objet extérieur type mur, clôture ou arbre dans l'entourage de la dalle. Si le produit est implanté près d'un mur, d'une haie ou d'un arbre il est nécessaire de l'éloigner des éléments extérieurs afin de pouvoir facilement le monter et l'entretenir. Nous nous dégageons de toute responsabilité en cas de mauvaise interprétation des dimensions de la dalle.

Le dimensioni del piano di base sono le dimensioni della soletta di cemento da realizzare su un terreno perfettamente piatto, senza alcun altro oggetto esterno, come un muro, una recinzione o un albero in prossimità della soletta. Se il prodotto è installato vicino ad una parete, un recinto o un albero, è necessario distanziarlo adeguatamente, in modo da poterlo facilmente montare e farne la manutenzione. Non ci assumiamo alcuna responsabilità per l'errata interpretazione delle dimensioni delle lastra.

**NOTICE DE MONTAGE du THERMA**  
Réf. THE3224.02T

Nous garantissons la fourniture des pièces détachées durant 2 ans à compter de l'achat du produit.  
Vérifier que vous avez bien toutes les pièces avant d'effectuer le montage

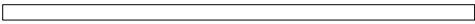
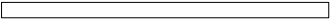
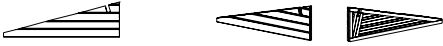
**Demande sav**

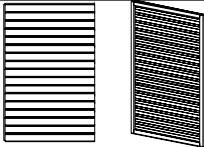
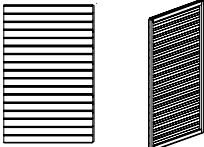
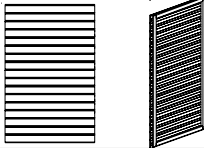
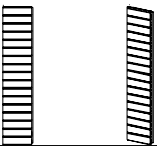
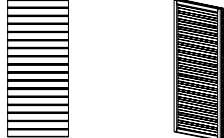
Réf.	Qté.	Dessin pièce	Dimensions (en mm)			Observation	Qté.
1	2		95	38	3120		
2	2		95	38	2170		
3	2		463	49	1530		
4	2		463	49	1530		
5	1		1200	49	1829		
6	1		1200	49	1829		
7	1		1180	49	1829		
8	1		400	49	1829		
9	1		800	49	1829		

A compléter impérativement pour toute demande SAV et à envoyer par mail à  
sav@foresta.fr + photo des pièces abîmées

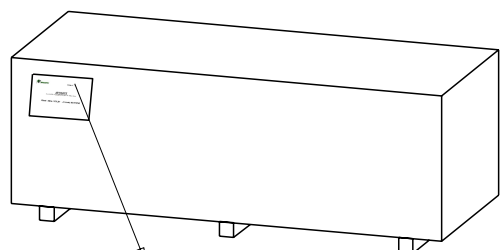

Colis n°: \_\_\_\_\_

THE3224.02T

Colis n°: \_\_\_\_\_











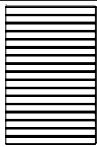

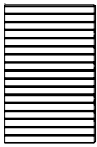

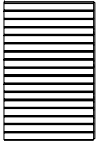

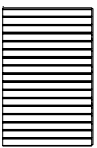
NOM DU MAGASIN  
(où l'abri a été acheté)

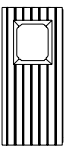
NOM DU CLIENT

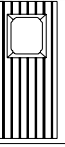
PRENOM DU CLIENT

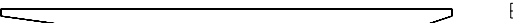
N° de téléphone

NOTICE DE MONTAGE du THERMA  
Réf. THE3224.02T

						Demande sav		
Réf.	Qté.	Dessin pièce		Dimensions (en mm)			Observation	Qté.
10	1			1200	49	1829		
11	1			1200	49	1829		
12	1			1180	49	1829		
13	1			1190	49	1829		
16	1			792	38	1815		
17	1			792	38	1815		
18	2			30	45	2980		
19	2			95	45	2980		
20	2			466	12	463		
21	1			40	20	1815		
d1	4			95	19	1780		

A compléter impérativement pour toute demande SAV et à envoyer par mail à  
sav@foresta.fr + photo des pièces abîmées

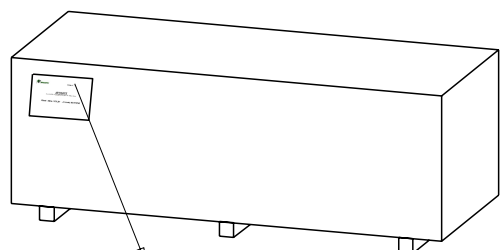

Colis n°: \_\_\_\_\_

THE3224.02T

Colis n°: \_\_\_\_\_









NOM DU MAGASIN  
(où l'abri a été acheté)

NOM DU CLIENT

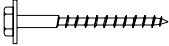
PRENOM DU CLIENT

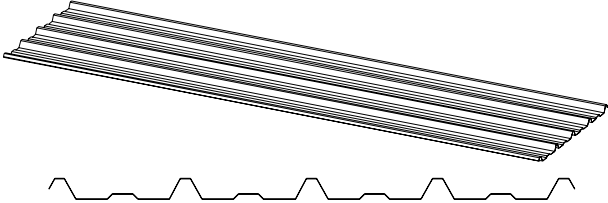
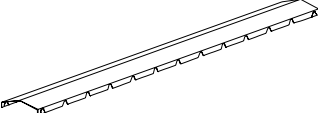
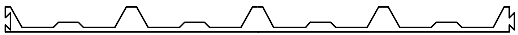
N° de téléphone

NOTICE DE MONTAGE du THERMA  
Réf. THE3224.02T

						Demande sav	
Réf.	Qté.	Dessin pièce	Dimensions (en mm)			Observation	Qté.
q1	14			ø 8	110		
q2	95			ø 5	80		
q3	130			ø 4	40		
q4	40			ø6.5	100		
q5	40		38	12	40		
q6	50			ø4.8	20		
q7	6		1000	40	1760		
q8	2						
q9	6						
q10	30			ø 3.5	30		
q11	6						
q12	1						
q13	2						

A compléter impérativement pour toute demande SAV et à envoyer par mail à  
sav@foresta.fr + photo des pièces abîmées

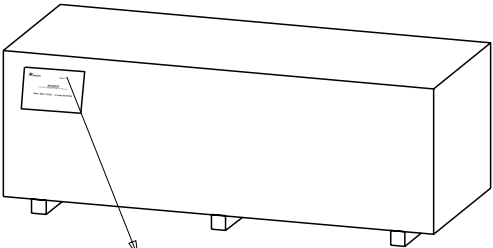
 <p>Colis n°: _____</p>	<p>THE3224.02T</p> <p>Colis n°: _____</p>	NOM DU MAGASIN (où l'abri a été acheté)	
		NOM DU CLIENT	
		PRENOM DU CLIENT	
		N° de téléphone	

Plan de soubassement

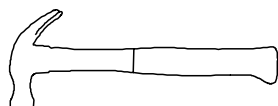
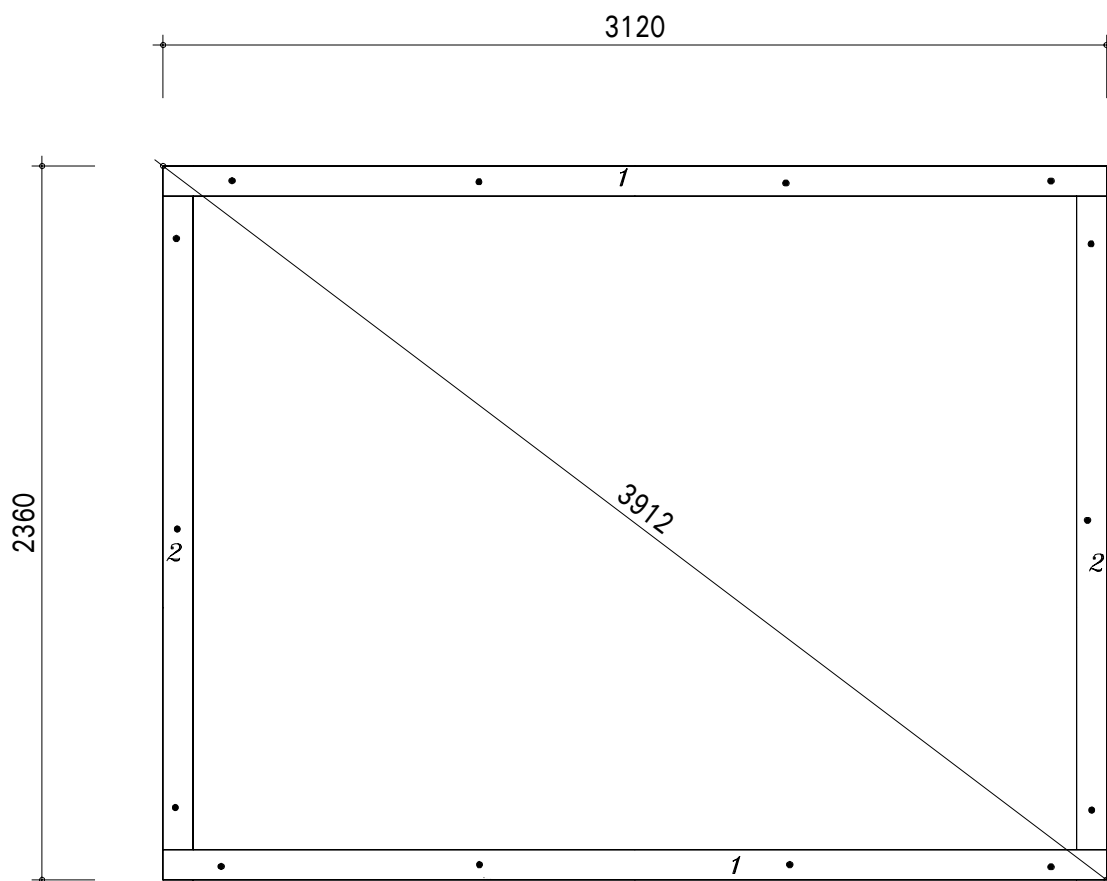

Tolérances à respecter (selon DTU 31.2):

- longueur et largeur:  $\pm 0,01$ m;
- équerrage:  $\pm 0,01$ m mesuré sur 10m;
- arase:  $\pm 0,01$ m sur une longueur de 10 mètres linéaires alignés ou non et de  $\pm 2$ mm par mètre linéaire;
- rectitude de bords en plan:  $\pm 5$ mm .

q1

Les dimensions données sur le plan de soubassement sont les dimensions de la dalle béton à réaliser sur un sol parfaitement plat sans aucun autre objet extérieur type mur, clôture ou arbre dans l'entourage de la dalle. Si le produit est implanté près d'un mur, d'une haie ou d'un arbre il est nécessaire de l'éloigner des éléments extérieurs afin de pouvoir facilement le monter et l'entretenir. Nous nous dégageons de toute responsabilité en cas de mauvaise interprétation des dimensions de la dalle.

Le dimensioni del piano di base sono le dimensioni della soletta di cemento da realizzare su un terreno perfettamente piatto, senza alcun altro oggetto esterno, come un muro, una recinzione o un albero in prossimità delle soletta. Se il prodotto è installato vicino ad una parete, un recinto o un albero, è necessario distanziarlo adeguatamente, in modo da poterlo facilmente montare e farne la manutenzione. Non ci assumiamo alcuna responsabilità per l'errata interpretazione delle dimensioni delle lastra.

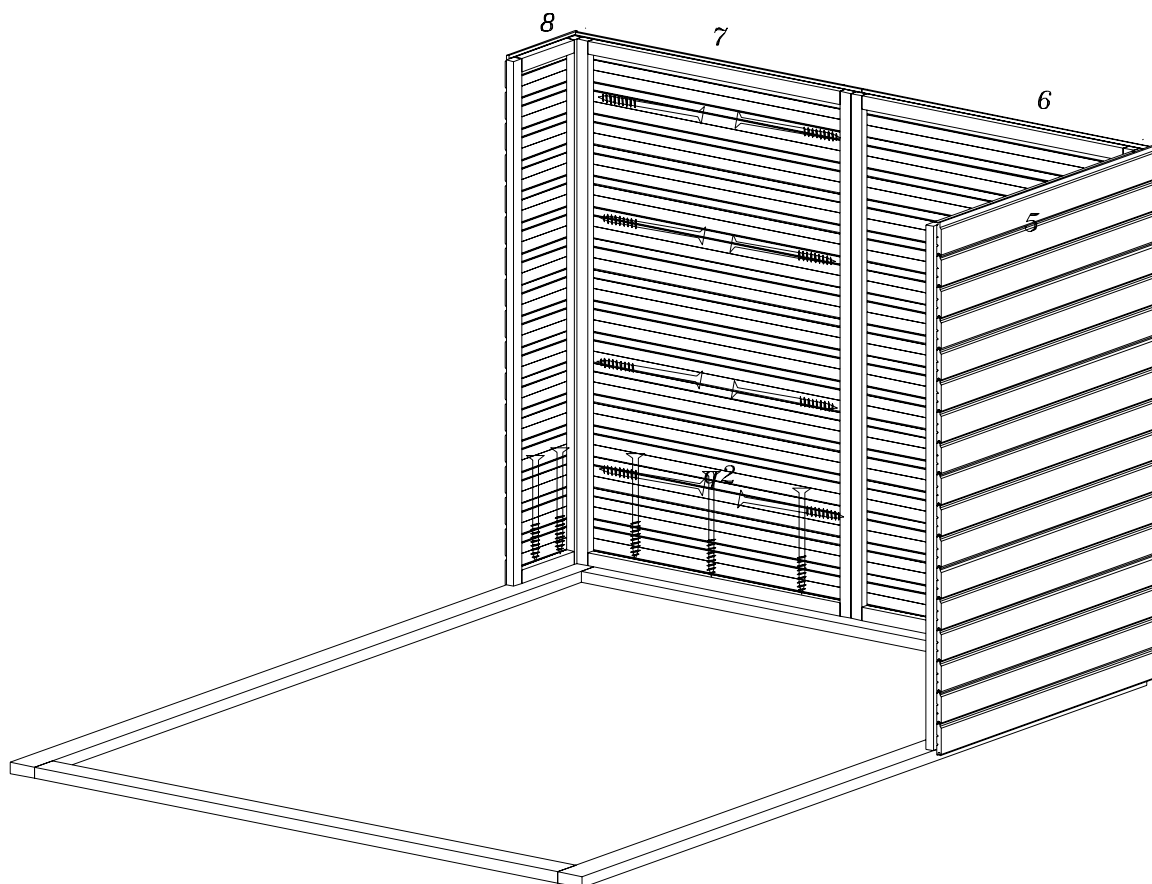
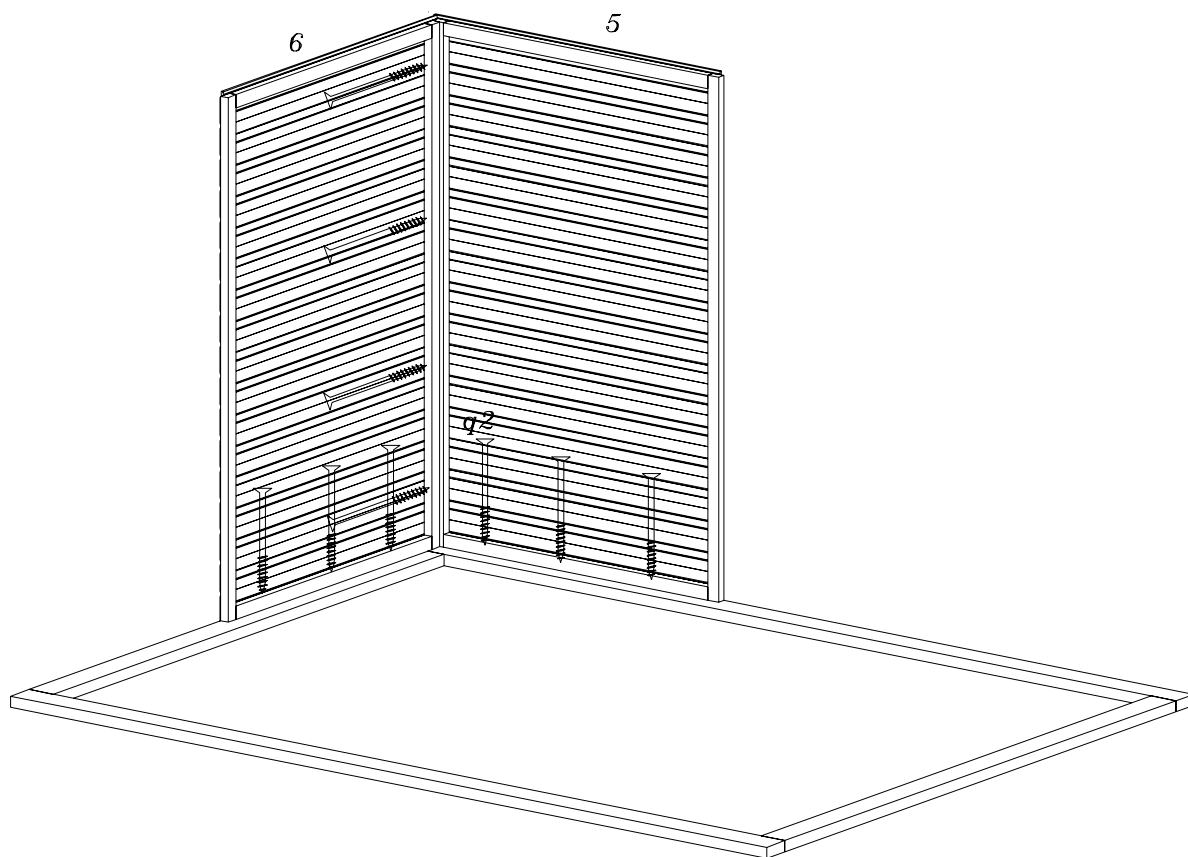

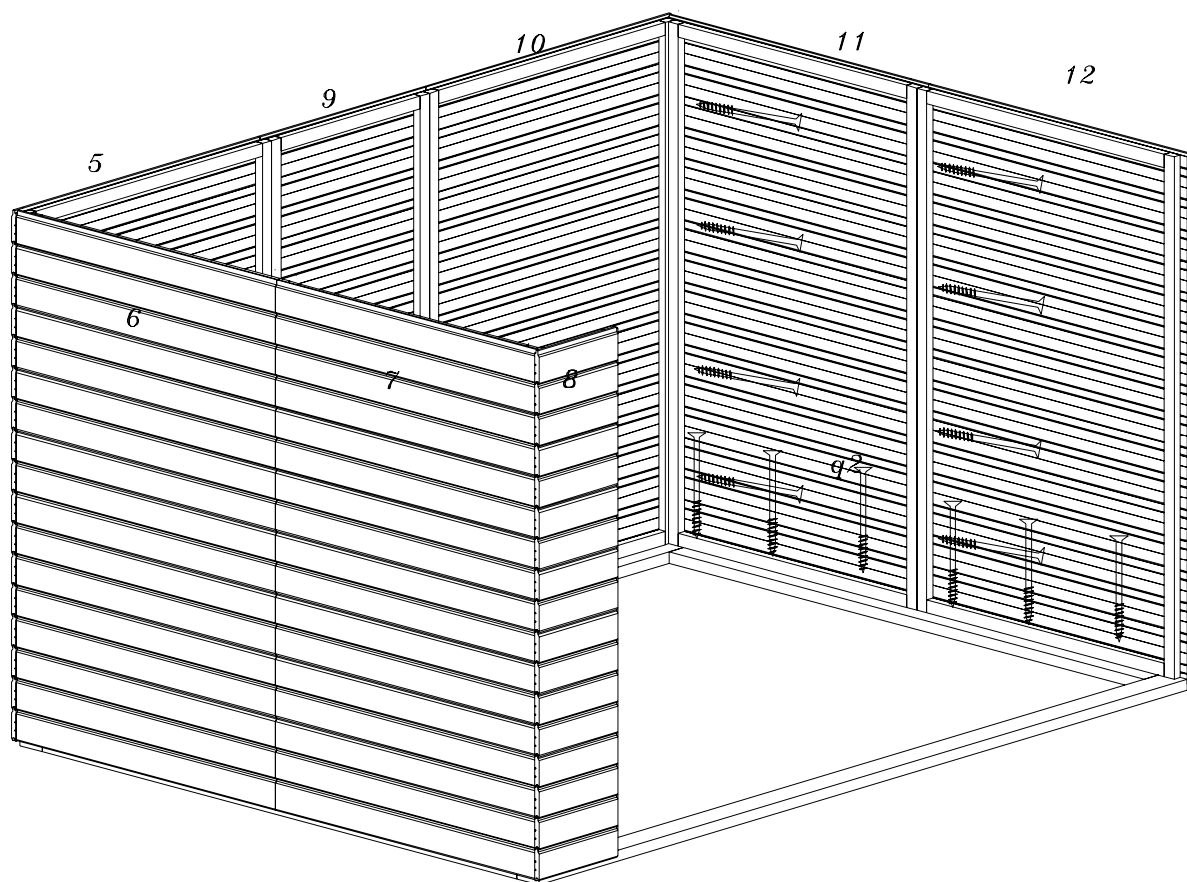
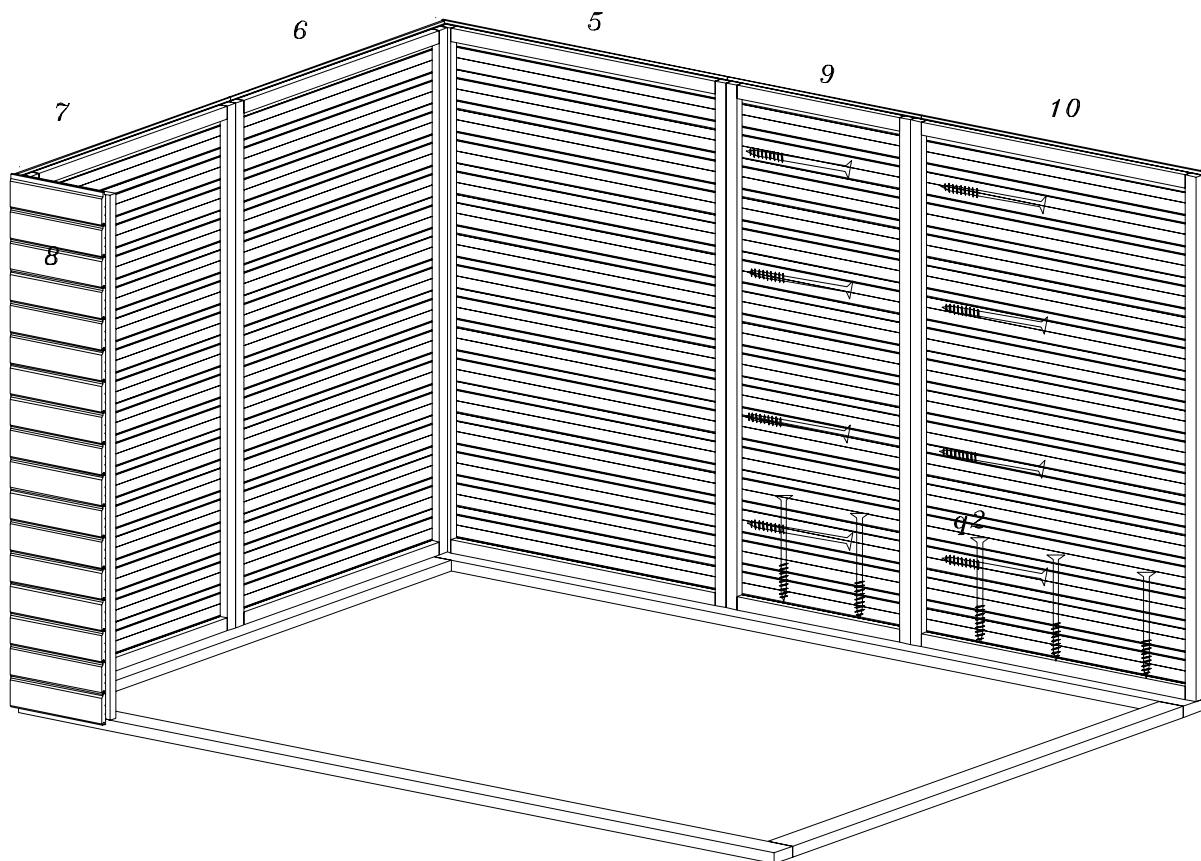

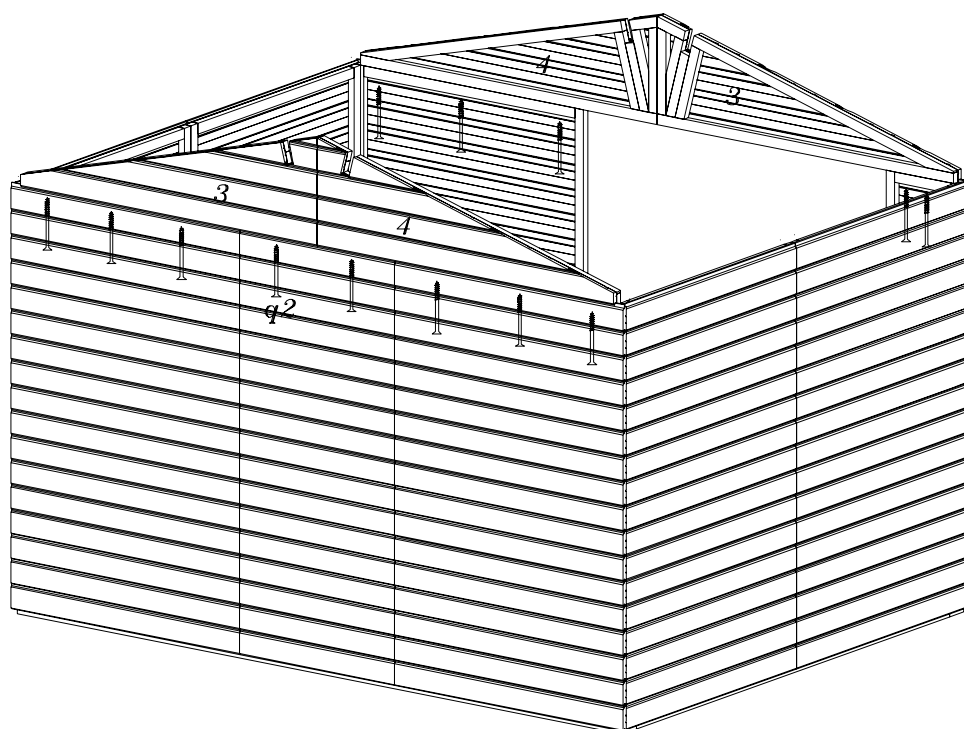
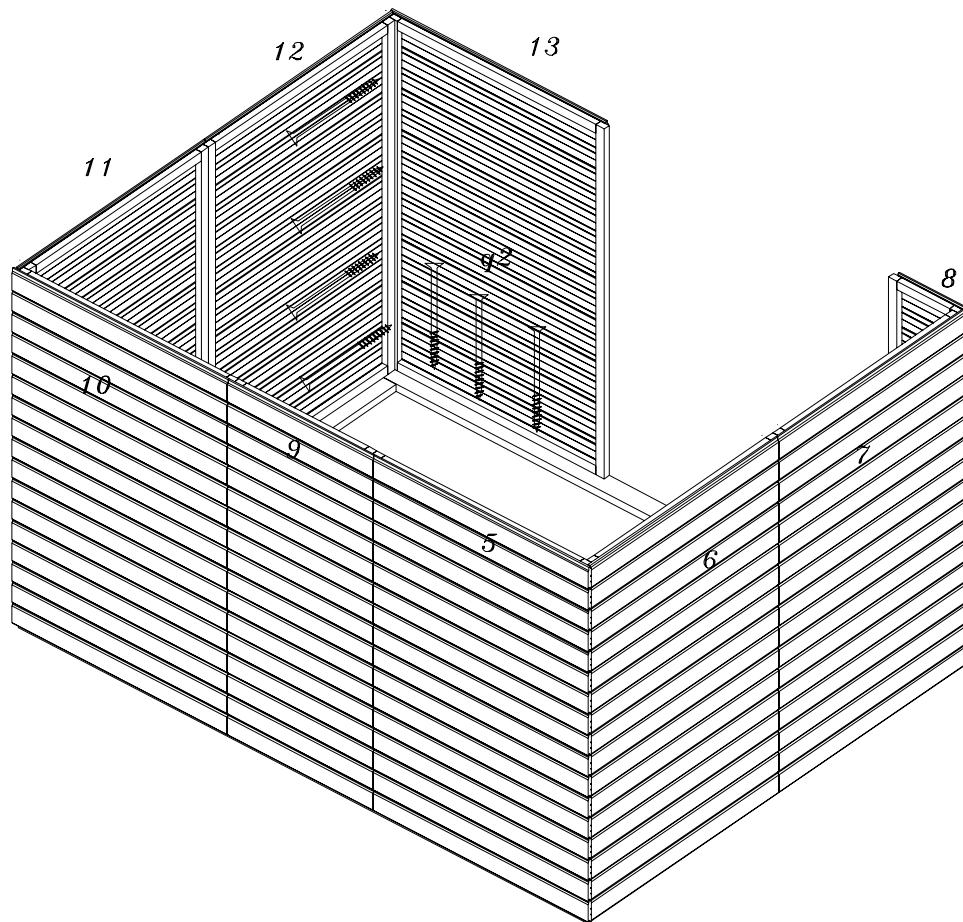

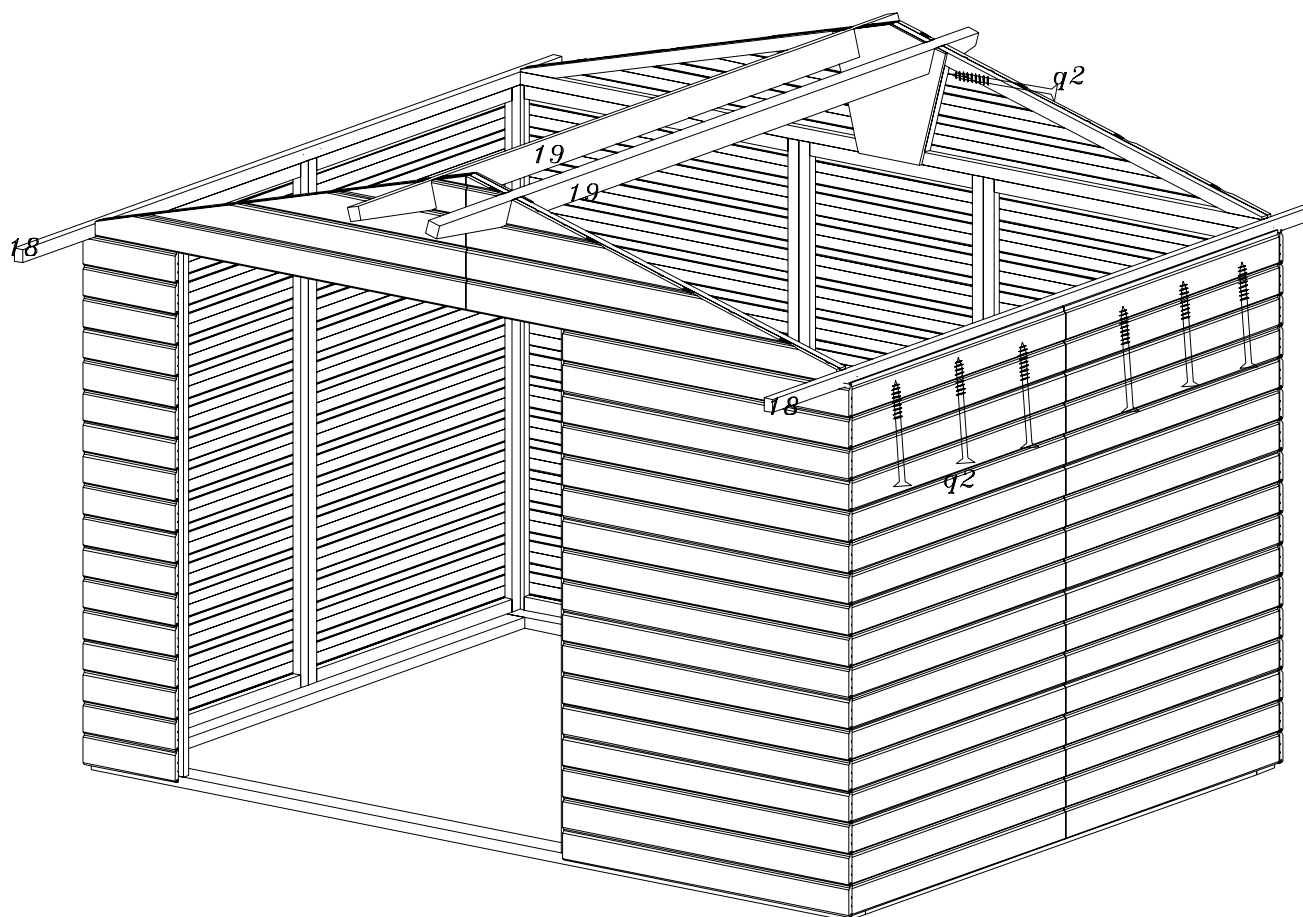
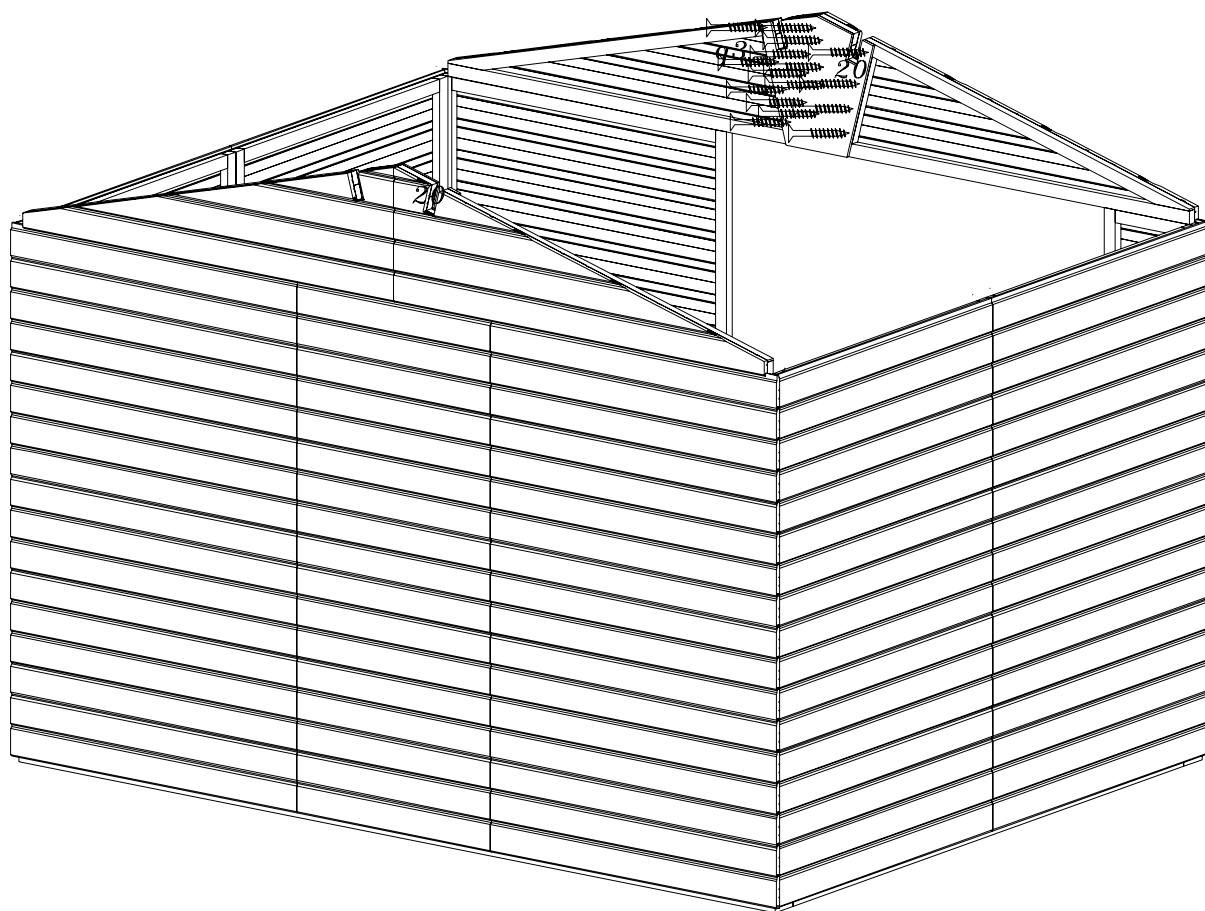

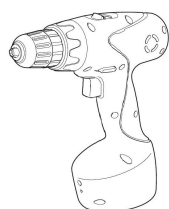
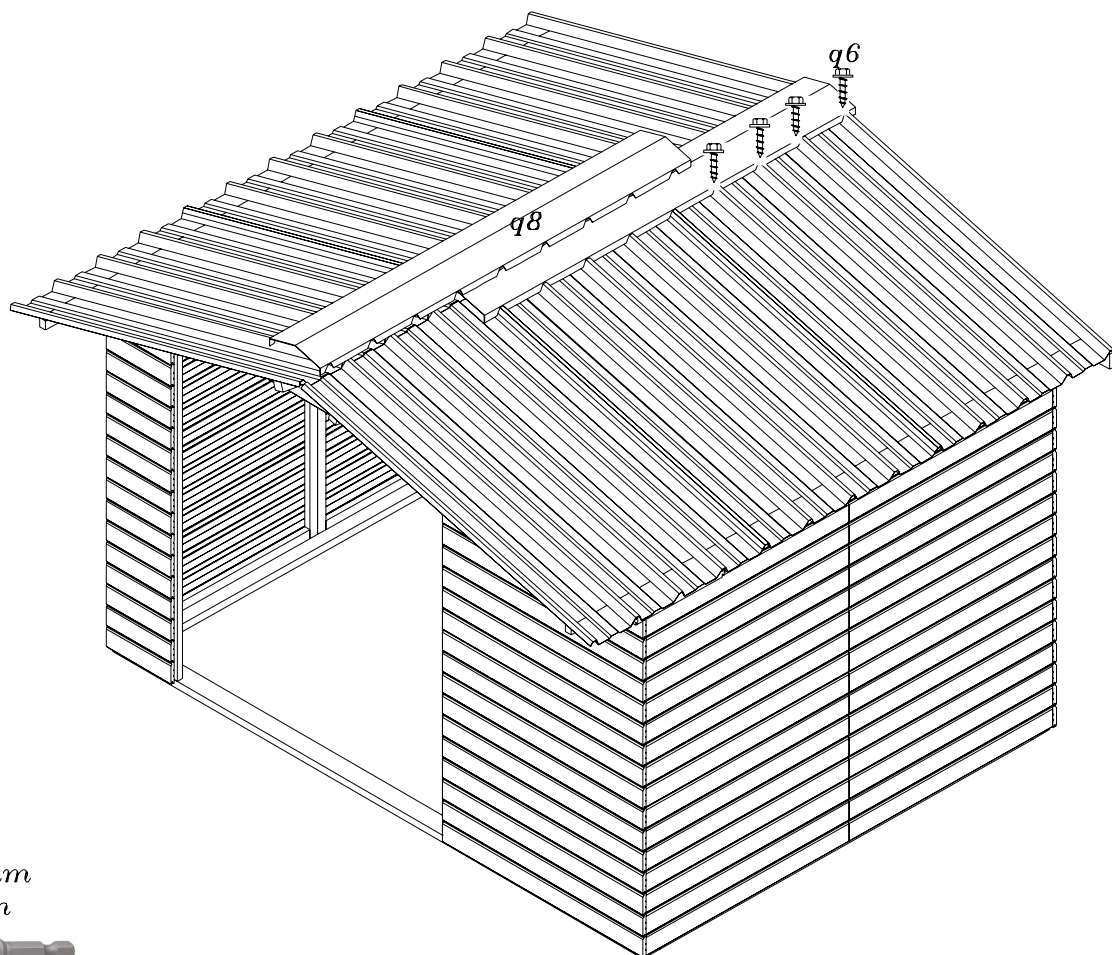
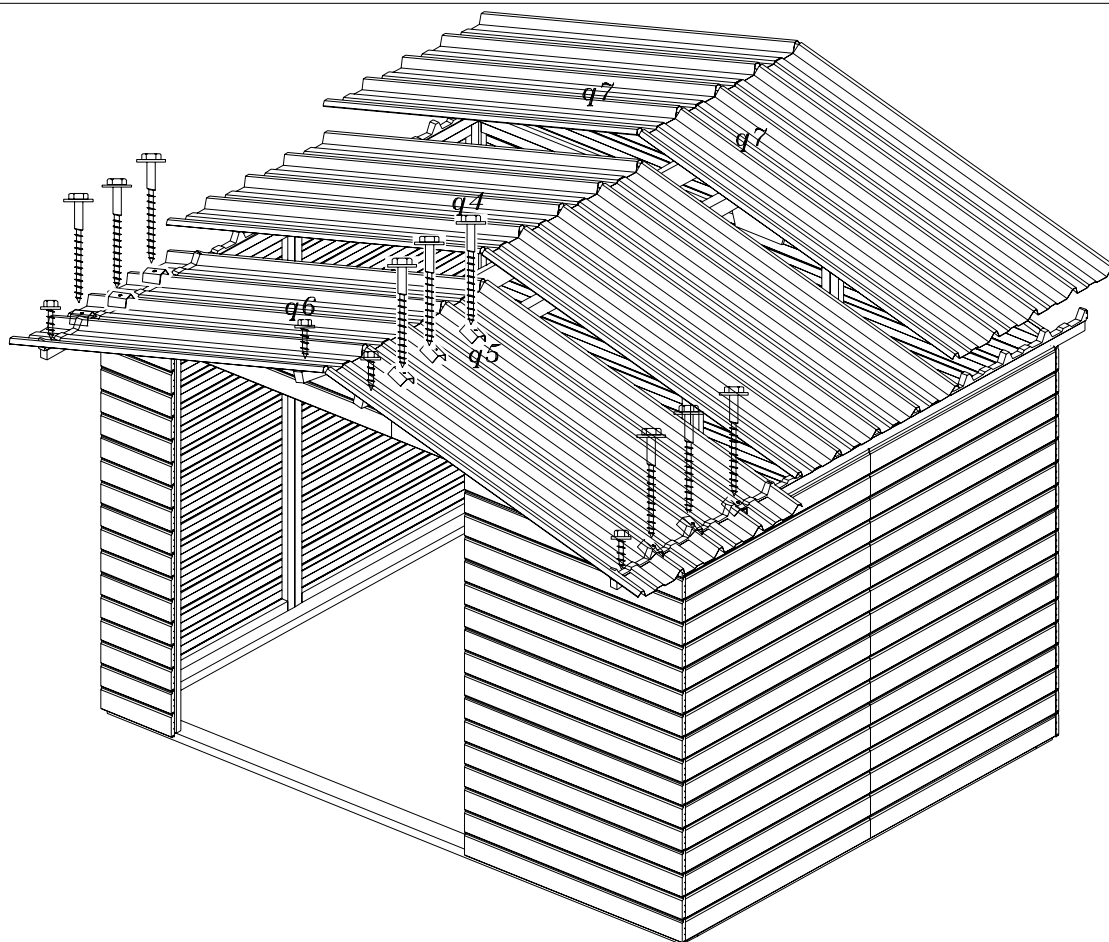

Ø12 mm  
Ø8 mm



